

SL30™

*nav com
pilot's guide*



© 2004 Garmin Ltd. or its subsidiaries

Garmin International, Inc.
1200 East 151st Street, Olathe, Kansas 66062, U.S.A.
Tel. 913/397.8200 or 800/800.1020
Fax 913/397.8282

Garmin (Europe) Ltd.
Unit 5, The Quadrangle, Abbey Park Industrial Estate, Romsey, SO51 9DL, U.K.
Tel. 44/0870.8501241
Fax 44/0870.8501251

Garmin Corporation
No. 68, Jangshu 2nd Road, Shijr, Taipei County, Taiwan
Tel. 886/2.2642.9199
Fax 886/2.2642.9099

Garmin AT
2345 Turner Rd., SE Salem, OR 97302
Tel. 503/581.8101 or 800/525.6726
Fax. 503/364.2138

All rights reserved. Except as expressly provided herein, no part of this manual may be reproduced, copied, transmitted, disseminated, downloaded or stored in any storage medium, for any purpose without the express prior written consent of Garmin. Garmin hereby grants permission to download a single copy of this manual onto a hard drive or other electronic storage medium to be viewed and to print one copy of this manual or of any revision hereto, provided that such electronic or printed copy of this manual must contain the complete text of this copyright notice and provided further that any unauthorized commercial distribution of this manual or any revision hereto is strictly prohibited.

Information in this document is subject to change without notice. Garmin reserves the right to change or improve its products and to make changes in the content without obligation to notify any person or organization of such changes or improvements. Visit the Garmin Web site (www.garmin.com) for current updates and supplemental information concerning the use and operation of this and other Garmin products.

Garmin®, GPSMAP®, AutoLocate®, TracBack®, Apollo, and MapSource® are registered trademarks of Garmin Ltd. or its subsidiaries and may not be used without the express permission of Garmin.

November 2004

Part Number 560-0403-01 Rev. C (Garmin P/N 190-00486-00)

Printed in the USA

Welcome ...

Welcome to a new era of aviation communication and navigation. Once again, Garmin AT, Inc. has set new standards in features and ease of use for the general aviation public. The SL30 is a VHF Navigation/Communications Transceiver for use by the aviation pilot. The SL30 is packaged in a slim form factor that helps you get the most out of limited panel real estate without limiting features and performance. The SL30 is unequalled in providing the features, level of performance, and reliability that aviation users expect. The high performance Digital Signal Processing (DSP) filter design of the SL30 allows it to track weaker VOR signals with more accuracy than conventional analog receivers. Add additional features like Morse code Station Identification and Multiple VOR tracking and you begin to understand the Advantages of DSP in a VOR Navigation System. The use of DSP technology in the SL30 provides a state-of-the-art device, which packs more performance in less space for less cost. You can be confident in knowing that you are the owner of the state-of-the-art in aviation communication and navigation. Our products are built to last and to allow the flexibility to meet your needs as they change in the future.

History of Revisions

Date	Software Version	Manual Revision
November 1999	1.0	Original Release
February 2000	1.1	560-0403-00 Rev a
August 2001	1.2	560-0403-01 Rev -
August 2003		560-0403-01 Rev a
November 2003		560-0403-01 Rev b
November 2004		560-0403-01 Rev c

Ordering Information

To receive additional copies of the SL30 User's Guide, order part #560-0403-xx. The SL30 Installation Guide is part #560-0404-xx. The Quick Reference Guide is part #561-0262-xx.

About This Manual

Please take a few moments to review the various sections in this manual. Even if you are an experienced user of Nav/Coms, be sure to read our Getting Started section. This section provides the rules for successful use of the SL30. The rest of the manual contains important information that you can refer to as you need more detail on specific procedures or features. The SL30 advances the technology of Nav/Coms and uses new state-of-the-art features you will want to know about.

- **Welcome**
Introductory statement, History of Revisions, and manual Ordering Information.
- **Getting Started**
Learn the rules for using your SL30.
- **Advanced Operation**
A detailed encyclopedia of the functions available in the SL30 including step by step directions.
- **Appendix**
Troubleshooting, Specifications, and Index.

Table of Contents

Welcome	i	Recalling Frequencies	7	Remote Localizer List	21
History of Revisions	i	Emergency Channel	8	Remote VOR list	21
Introduction.....	i	Advanced Operation.....	9	Automatic Nav Channel List.....	21
Ordering Information	ii	Com Radio Mode	9	Nav User Channel List.....	21
About This Manual.....	ii	Monitoring the Standby Com channel.....	9	DST Data Display	22
Getting Started	1	Saving a Com channel.....	9	Enable DST Data Display	22
Display.....	2	Removing a Com channel.....	10	Disable DST Data Display.....	22
TX	2	Changing or Replacing a Saved Com Channel.....	10	OBS Mode.....	23
Controls.....	2	Recalling Com Channels	11	OBS Operation	23
Power On/Off - Volume - Squelch	2	Remote Com Channel Lists	12	OBS Direct-To	23
Large/Small knobs.....	2	Automatic Com Channel List (Autolist).....	12	OBS Mode Disabled	23
Flip/Flop.....	3	User Com Channel List.....	12	CDI.....	23
Com.....	3	Weather Channels	13	Localizer.....	25
NAV	3	Emergency Channel	13	Back Course	25
SYS	3	Stuck Mic	14	To/From Radial.....	26
OBS.....	3	Intercom Function	14	System Mode.....	28
T/F	3	Nav Radio Mode.....	15	System Info	29
ID	4	Monitoring the Standby Nav channel	15	Software Version.....	29
SEL	4	Using the Standby Channel to Monitor a Second		Low and High Display Intensity	29
ENT	4	VOR.....	15	Nav Options.....	30
Operation Summary	5	Navigating along a Back Course approach...	16	Nav Audio Level.....	30
Power On.....	5	Navigating to a MAHP.....	17	Nav/Com Mixing Level.....	30
Selecting a Com Frequency	6	Listening to the Audio channel.....	18	Additional CDI Info	30
Selecting a Nav Frequency.....	6	Automatic Morse Code Decode/Display.....	18	Display Ident over OBS	30
System Mode.....	7	Saving a Nav channel	19	Com Options	31
OBS Mode.....	7	Removing a Nav channel.....	19	RF Signal Level.....	31
		Recalling a Nav channel	20	Com Noise Level	31
				Mic 1 and 2 Squelch	31

Introduction

Transmit Mic	31
Intercom Level	32
Sidetone Level	32
Headphone Level	32
VOR Equipment Test	32
Appendix	33
Troubleshooting	33
Installation Configurations.....	36
Specifications	37
General Features	37
Com Radio Features	38
Physical Specifications.....	38
NAV Radio Performance Specifications.....	39
Com Radio Performance Specifications	39
System Interfaces.....	40
Navigation Receiver.....	40
Com Transceiver	40
Serial Interface	40
Localizer and Paired Glideslope Frequencies	41
VOR Station Frequencies	43
Compliance, License, and Warranty Information .	44
FCC Compliance	44
Software License Agreement	45
Product Registration and Support.....	45
Limited Warranty	46

Getting Started

Combining a powerful 760 channel VHF communications transceiver with 200 channel VOR, Localizer and Glideslope receivers, the SL30 provides a full-functioned navigation and communications solution in a small footprint at a very affordable price. Besides traditional Nav/Com features, the SL30 also incorporates workload-reducing functions such as automatic decoding of the Morse code station identifier for VOR/LOC, most-used frequency storage in memory, built-in course deviation indicator, and more.

The SL30, the smallest Nav/Com on the market, is loaded with features and functionality. The only Nav/Com with the ability to monitor the standby Com and Nav frequencies, the SL30 VHF Nav receiver operates from 108 MHz to 117.95 MHz decoding both the VHF Omni Range and Localizer navigation signals. The built in Glideslope receiver will automatically tune the corresponding glideslope paired frequencies (328 MHz to 335 MHz) when the localizer is tuned. The SL30 includes the powerful yet efficient 8 watt com transmitter used in the other SL Slimline and GX avionics.

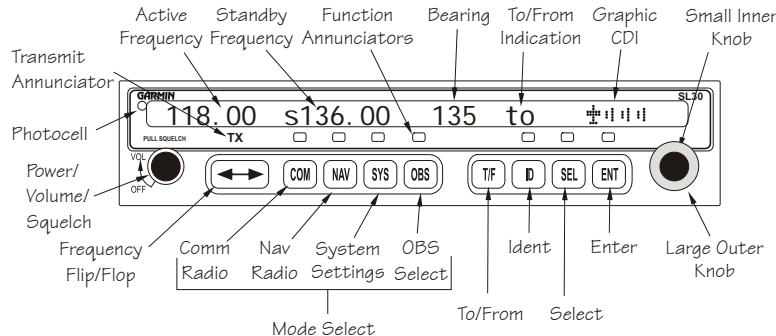

Display

The SL30 Nav/Com uses a single line by 32-character 5x7 dot matrix alphanumeric display. A photocell is located in the top left corner of the front panel display. The photocell automatically controls the light intensity of the display LEDs from low brightness at night to high brightness during daylight operation. The lens is polarized to reduce reflections. Using polarized sunglasses may make it difficult to view the display.

TX

A transmit (TX) indicator located above the **FLIP/FLOP** button lights when the Com radio is transmitting.

Controls

Power On/Off - Volume - Squelch

The knob on the left side of the SL30 controls power on/off, volume, and squelch test. Rotate the knob clockwise (CW) past the detent to turn the power on. Continuing to rotate the knob to the right increases speaker and headphone amplifier volume level. Rotate the knob to the left to reduce the volume level. Pull the knob out to disable automatic squelch. The SL30 may be configured to have the volume knob control Nav and intercom volume, as well as Com volume .

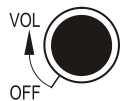

Large/Small knobs

The dual concentric knobs on the right side of the SL30 are used to select frequencies, to view the features available within a function, or make changes. Details are provided in the appropriate sections.

Flip/Flop

Press the **FLIP/FLOP** button to switch between the active (left-most) and standby (right-most) frequency. Switching between Com frequencies is disabled while you are transmitting.

Com

Press **COM** to select the Com radio mode. The annunciator will light above the button when you are in Com mode. Press **COM** a second time to monitor the Standby frequency. See the Advanced Operation section for more about monitoring frequencies.

NAV

Press **NAV** to select the Nav radio mode. The annunciator above the button will light when you are in Nav mode. Press **NAV** a second time to monitor the Standby frequency. See the Advanced Operation section for more about monitoring frequencies.

SYS

Press **SYS** to reach the System mode. The annunciator above the button will light when you are in the System mode.

OBS

Press **OBS** to see the current OBS setting and graphic CDI. If the annunciator above the **OBS** button lights, you may use the **LARGE** and **SMALL** knobs to change the displayed OBS values.

If your system is configured with an external CDI/HSI, the OBS radial of your remote display will be decoded and displayed on the screen of the SL30.



COM

NAV

SYS

OBS

T/F

ID

SEL

ENT

T/F

Press **T/F** to toggle between the bearing TO or radial FROM the active VOR. The **T/F** button does not operate for Localizer frequencies.

ID

Press **ID** to select the Nav audio and toggle between VOICE or IDENT. Pressing **ID** will cancel the VOR monitor function. Selecting the monitor function will suspend the ID function until the monitor function is disabled.

SEL

Press **SEL** to choose from a list of channel types or to change values. In Com or Nav modes, press **SEL** to choose frequencies from the available lists. Press **SEL** again if you want to cancel the selection process. The annunciator will light above the button when this function is active.

ENT

Press **ENT** to save selected values, to confirm a prompt, or to save the Standby frequency.

Operation Summary

Power On

Turn the SL30 on. Either turn the Power/Volume knob clockwise to turn the power on or, if installed, turn on the master switch that powers the radios.

The SL30 will go through a short initialization routine and then briefly display the last VOR check date. If you turn the SL30 off for less than 15 seconds and then back on, it will bypass the initialization process and return to the last used display.

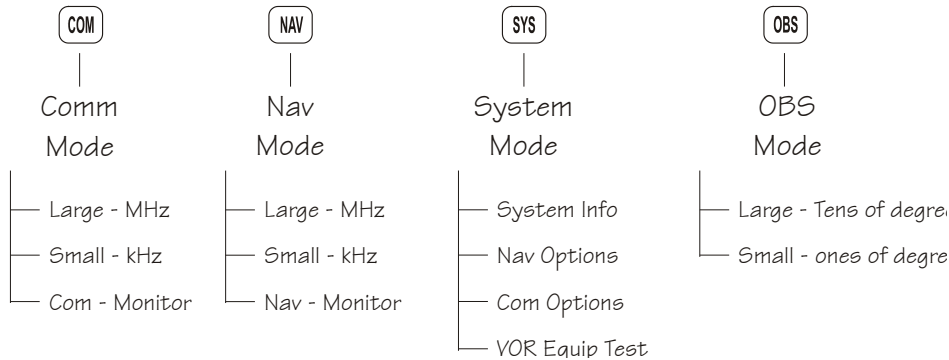

Selecting a Com Frequency

New frequencies are first selected as a Standby frequency and then toggled to the Active side when desired. While viewing the Standby frequency display, use the **LARGE** and **SMALL** knobs on the right side of the SL30 to select the desired frequency.

1. Press **COM** to reach the Com radio function. The annunciator above the **COM** button will light.
2. Turn the **LARGE** knob to change the values in one MHz increments. The MHz selection range is between 118 and 136 in one MHz steps.
3. Turn the **SMALL** knob to change the values in 25 kHz increments. The kHz selection range is between 000 and 975 kHz in 25 kHz steps. Note that only two digits are displayed to the right of the decimal point.
4. Turn the **LARGE** and **SMALL** knobs clockwise to increase and counterclockwise to decrease the frequency values. Standby frequency selection is not inhibited during transmit.
5. Press the **FLIP/FLOP** button to toggle the Standby frequency to the Active frequency.

Selecting a Nav Frequency

The selection of Nav frequencies is the same as for the Com frequencies. The annunciator above the **NAV** button will light.

1. Press **NAV** to reach the Nav radio function.
2. Turn the **LARGE** knob to change the values in one MHz increments. The MHz selection range is between 108 and 117 in one MHz steps.
3. Turn the **SMALL** knob to change the values in 50 kHz increments.
4. Press the **FLIP/FLOP** button to toggle the Standby frequency to the Active frequency.



Note: You cannot display both Nav and Com frequencies at the same time.

System Mode

In the System mode you can view software versions, setup the Nav and Com functions, and record VOR test information. See the Advanced Operations section for more details.

OBS Mode

Press the **OBS** button. If the annunciator above the button lights, then you may use the **LARGE** and **SMALL** knobs to adjust the Omni Bearing Selector.

Recalling Frequencies

In the Com or Nav modes, press **SEL** to gain access to the available frequency lists of each mode. Turn the **LARGE** and **SMALL** knobs to view the available channels.

1. Press **COM** or **NAV** to go to the desired mode.
2. Press **SEL** to go to the frequency database.
3. Turn the **LARGE** knob to review the type of frequency.
4. Turn the **SMALL** knob to display the available channels in the selected type.
5. Press **ENT** to put the displayed channel into the Standby position or press **FLIP/FLOP** to put the displayed channel into the Active position. You can press **SEL** again to cancel selection.

Emergency Channel

The standard emergency channel (121.50 MHz) is stored in the Com memory of the SL30.

1. Press **COM**, if you aren't in Com mode already. Press **SEL**. Turn the **LARGE** knob to the Emergency channel, one position counter-clockwise will reach it fastest.

119. 10 s124. 55 emrgncy 121. 50

2. Press the **FLIP/FLOP** button to make the Emergency channel the Active channel.
3. Listen, or key the Mic to send your message.

Advanced Operation

Com Radio Mode

Monitoring the Standby Com Channel

The Frequency Monitoring function allows you to monitor the Standby frequency for activity, while listening to the Active frequency.

Press the **COM** key in the Com function to listen to the standby frequency. A small “m” will replace the “S” in front of the Standby frequency.

119. 10 m124. 55 PDX from 115

When the Active frequency receives a signal, the unit will switch automatically to the Active frequency. The Active frequency quality is not affected. The Frequency Monitor function is turned off when you flip/flop frequencies, recall a frequency, or press **COM** again. Monitoring is not canceled by switching to Nav mode.

Saving a Com Channel

You can save the Standby frequency and give it a name of up to four characters. A combination of up to 250 Com and Nav frequencies may be saved. After 250 Nav and Com frequencies are saved, you will get a “Database Full” message. You will have to remove frequencies before any more can be saved.

A frequency type can also be assigned along with the saved selection. Types available include: Tower (TWR), Ground Control (GND), ATIS (ATS), Air Traffic Frequency (ATF), Approach (APP), Arrival (ARR), Automated Weather Station (AWS), Clearance (CLR), Common Traffic Advisory Frequency (CTF), Departure Control (DEP), Flight Service Station (FSS),

Remote Flight Service Station (RFS), Unicom (UNI), and Mandatory Frequency (MF).

1. While in Com mode, press **ENT**. The right side of the display will show "store as" with a flashing cursor at the first character of the name.

119. 10 s124. 55 store as _

2. Turn the **SMALL** knob to choose the desired character.
3. Turn the **LARGE** knob to move to the next character position.
4. After you turn the **LARGE** knob one position clockwise past the fourth character, three underscores at the end of the line will flash.
5. Turn the **SMALL** knob to choose the desired type.
6. Press **ENT** after making your selections. Press **SEL** if you do not want to save the frequency.

Removing a Com Channel

You may only remove channels stored in the User list.

1. In Com mode, press **SEL**.
2. Turn the **LARGE** knob to the User list and then turn the **SMALL** knob to the desired channel.
3. Press **SEL**. "Remove?" will flash on the right side of the display.

119. 10 s124. 55 SLE ats Remove?

4. Press **ENT** to remove the channel from the User list or press **SEL** to exit without making changes.

Changing or Replacing a Saved Com Channel

Channels you have saved in the User list may be changed or updated by replacing the frequency, but keeping the same name and type.

1. Note the name of the channel you want to change. You are going to use the same name and type for a new channel.
2. Turn the **LARGE** and **SMALL** knobs to display the desired Standby frequency.

3. Press **ENT**. The right side of the display will show "store as" with a flashing cursor at the first character of the name.
4. Use the **LARGE** and **SMALL** knobs to enter the previously used name and frequency type.
5. Press **ENT**. The previously used name and frequency are now replaced with your new entry.

Recalling Com Channels

There are several lists of channels that you can recall from memory, they are: remote channels, the ten most recently used channels, user-stored channels, weather channels, and the emergency channel. The lists available depend on your installation. Pressing **ENT** selects this entry as the standby channel. Press the **FLIP/FLOP** button to select this entry as the active channel.

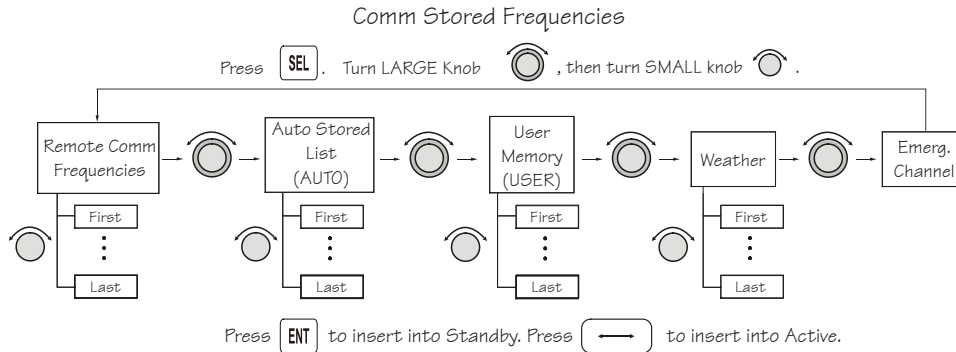

Remote Com Channel Lists

Database information can be read when your SL30 is connected to another device, such as the SL60. Each remote list begins with a facility identifier, such as PDX, SLE, LAX, etc. The **LARGE** knob scrolls through the remote, and other, lists. The **SMALL** knob scrolls through the channels in each list. A diamond indicates that more channels are available for the displayed facility.

119. 10 s124. 55 PDX ats 128. 35Y

Automatic Com Channel List (Autolist)

The last ten used active frequencies are available separately for Nav and Com channels (ten for Nav and ten for Com). The channels are stored in chronological order beginning with the most recent used. Duplicates are not saved again, but they are moved to the front of the list. The **SMALL** knob is used to view entries in the list.

119. 10 s124. 55 autolist 119. 10Y

User Com Channel List

The Com channels that you saved are in this list. In Com mode you will see the channels you saved while in Com mode. This list is arranged alphabetically by name. View the saved channels by rotating the **SMALL** knob. Press the **FLIP/FLOP** button to make the viewed channel the Active channel. Press the **ENT** button to make the viewed channel the Standby channel.

119. 10 s124. 55 SLE ats 124. 55Y

Weather Channels

The standard weather channels are stored in the memory of the SL30. You cannot transmit on a weather channel frequency. Weather channels are not available in all locations.

Weather Frequencies

162.400 MHz
162.425 MHz
162.450 MHz
162.475 MHz
162.500 MHz
162.525 MHz
162.550 MHz

1. In Com mode, press **SEL**. Turn the **LARGE** knob to the Weather channels.

119. 10 s124. 55 weather 162. 40Y

2. Turn the **SMALL** knob to choose the desired weather channel.
3. Press the **FLIP/FLOP** button to make the selected weather channel the Active channel.

Emergency Channel

The standard emergency channel (121.50 MHz) is stored in the memory of the SL30.

1. Press **SEL**. Turn the **LARGE** knob to the Emergency channel.

119. 10 s124. 55 emrgncy 121. 50

2. Press the **FLIP/FLOP** button to make the Emergency channel the Active channel.

Stuck Mic

The SL30 helps protect you from a situation where the microphone may get stuck in the ON or Transmit position. If the microphone is keyed for longer than 35 seconds, the SL30 will return to the receive mode on the selected frequency.

A “**Stuck Mic**” message will display until the transmit key is released.



Note: In an emergency situation, if the “Stuck Mic” message remains after you have stopped keying the mic, turn the power off and then back on. You will then get another 35 second time-out period to transmit.

Intercom Function

When two headphone and microphone jacks are connected to the SL30. Headsets can be used in conjunction with the internal voice-activated intercom.

When you select the Intercom function with the installed selector switch, the intercom function is enabled. The Volume control may control the headphone listening level. See the System Mode information for setting up the Mic squelch, transmitting mic, and Intercom volume.

Nav Radio Mode

Monitoring the Standby Nav channel

The Nav radio provides a monitor function for VORs as the standby channel similar to the Com radio. The monitor function is activated or deactivated by pressing the **NAV** button while in the Nav function. The From radial for the standby channel is shown in parentheses when the VOR monitor mode is activated. This replaces the station identifier, OBS course, or VOR/LOC indicator. A small “m” will replace the “S” in front of the Standby frequency. The Standby VOR radial is updated once per second. You cannot monitor a Localizer channel.

111. 80 m117. 40 (267) from 115

If no signal can be tracked on the standby channel, then it will be dashed out.

111. 80 m115. 40 (---) from 115

The VOR Monitor function is turned off when you flip/flop frequencies, recall a frequency, or press **NAV** again. Monitoring is not canceled by switching to Com.

Using the Standby Channel to Monitor a Second VOR

You can use the monitor function of the Standby channel as if it were a second Nav receiver. This is useful to check for crossing points on the course you are navigating along. The two following examples show how to monitor the second channel. You can use these examples to develop your own solutions for other in-flight navigation needs.

Navigating along a Back Course approach

1. Press **NAV** to select the Nav receiver.
2. Set the Localizer frequency of your approach as the Active channel.
3. Press **SEL**. The display will prompt you to enable the back course. Press **ENT** to enable the back course. Press **SEL** and **ENT** again to disable the back course when it's appropriate. When Back Course is enabled, it is noted by "bc" on the display.
4. Set the Standby channel to the appropriate VOR and note where a radial crosses the FAF and MAP for your approach. Press **NAV** a second time to "monitor" the Standby channel. A small "m" will replace the "s".
5. The internal CDI (on the right side of the display) and the external CDI, if installed, will guide you along the course to the runway.
6. The radial of the Standby channel you are monitoring will be shown in parentheses to the right of the Standby channel.
7. Use the monitored Standby channel to note your location along the approach.

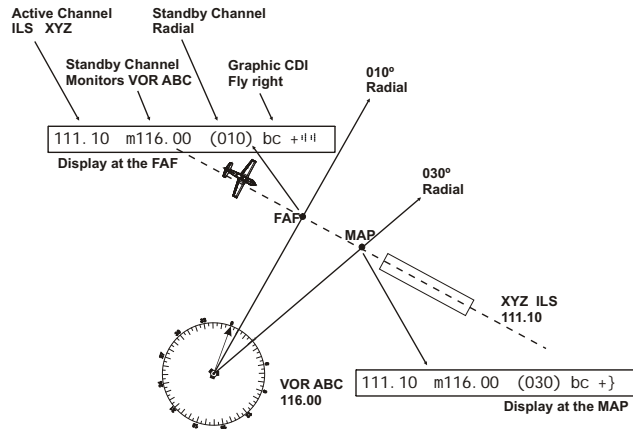

Navigating to a MAHP

1. Press **NAV** to select the Nav receiver.
2. Set the VOR frequency for the radial you are following to the MAHP as the Active channel.
3. Set the Standby channel to the appropriate VOR and note where a radial crosses the MAHP for your runway. Press **NAV** a second time to "monitor" the Standby channel. A small "m" will replace the "s".
4. The Active channel will drive the internal CDI (on the right side of the display) and the external CDI, if installed.
5. The radial for the Standby channel you are monitoring will be shown in parentheses to the right of the Standby channel.
6. Use the monitored Standby channel to note your location along the path to the MAHP. You will be at the MAHP when the Standby channel displayed radial matches the target radial.

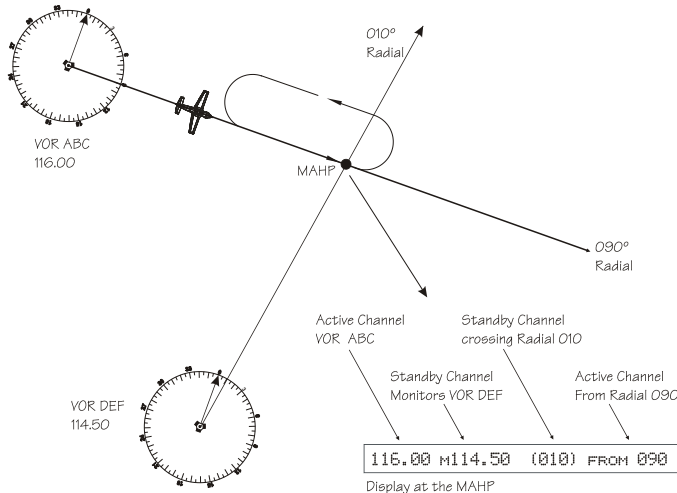

Listening to the Audio channel

The audio for the active Nav channel is toggled between modes using the **ID** button. The annunciator above the button will light while Nav audio is activated, and the detected audio signal will be sent to the Nav audio output circuit. Nav audio may also be mixed with the Com audio output, if selected in the System mode. When you are monitoring a VOR, Nav audio is suspended.

There are three modes for the Nav audio. Press the **ID** button to start the ID mode. “IDENT” will be displayed for three seconds. The Morse code tones sent over the VOR/Localizer channels will be heard.

If the **ID** button is pressed a second time. “VOI CE” will be displayed for three seconds. The Morse code tone volume will be reduced so you can hear the voice transmission more clearly.

Press **ID** again to turn the audio and ID annunciator off.

The last audio output selection is kept in memory until you change it, even when the SL30 is powered off. Using this feature, you may leave the audio enabled and then control it by an external audio panel.

Automatic Morse Code Decode/Display

The Morse code identifier will not be available until two messages have been successfully received, which may take from 15-60 seconds depending on conditions. When no voice is present on the station, the Morse code identifier is decoded correctly at least 99.5% of the time. If the station is transmitting voice along with the Morse Code identifier, the probability of the SL30 to decode the identifier drops to 95%. Voice or poor reception (such as the station is far away) may delay or inhibit the automatic decode function.

Saving a Nav channel

You can save the frequency in the Standby position and give it a name of up to four characters. Additional information can be saved along with the name, if the selection is a Localizer or ILS. ILS selections may include the runway number (01-36) and designation (L, R, or C). Up to 250 Com and Nav frequencies may be saved. After 250 Nav and Com frequencies are saved, you will get a “Database Full” message. You will have to remove frequencies before any more can be saved.

1. While in Nav mode, press **ENT**. The right side of the display will show “store as” with a flashing cursor.

108. 10 s111. 10 store as _ i l s

2. Turn the **SMALL** knob to choose the desired character.
3. Turn the **LARGE** knob to move to the next character position.
4. If it is a Localizer frequency, after you turn the **LARGE** knob one position clockwise past the fourth character, the **LOC** label will flash.
5. Turn the **SMALL** knob to choose the runway number (01-36).
6. Turn the **LARGE** knob one position clockwise. An underscore will flash. Turn the **SMALL** knob to choose L, R, or C to identify the runway, as desired.
7. Press **ENT** after making your selections. Press the **SEL** button if you do not want to save the frequency.

Removing a Nav channel

You may only remove channels stored in the User list.

1. In Nav mode, press **SEL**.
2. Turn the **LARGE** knob to the User list. Turn the **SMALL** knob to the desired channel.
3. Press **SEL**. “Remove” will flash on the right side of the display.
4. Press **ENT** to remove the channel from the User list. You may also press **SEL** again to cancel the process.

Recalling a Nav channel

There are several lists of channels that you can recall from memory in Nav mode. Remote Localizer, remote VORs, the ten most recently used channels in Nav mode, and the user-stored channels.

1. In Nav mode, press **SEL**.
2. Turn the **LARGE** knob to the desired list.
3. Turn the **SMALL** knob to view the available channels in each list.
4. Press **ENT** to select the entry as the standby channel. Press the **FLIP/FLOP** button to select this entry as the active channel.

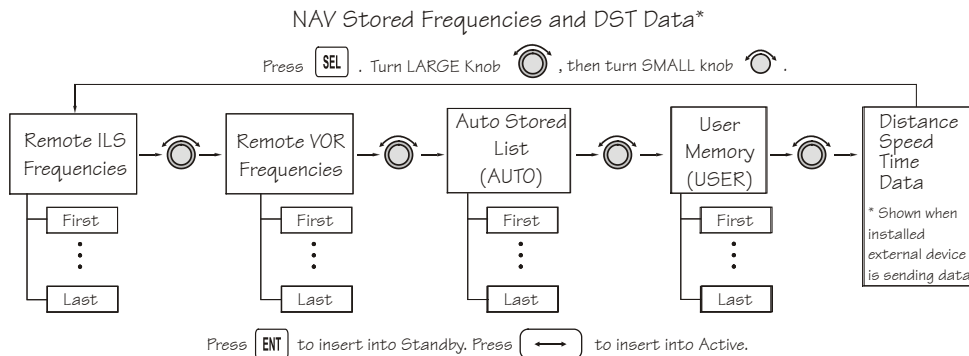

Remote Localizer List

If Localizer channels have been sent by an external device, then this list will be the first displayed for convenience while preparing for a landing. The list shows the airport identifier on the left, a runway identifier for the station in the center, and the channel frequency on the right. If multiple Localizer frequencies are available at the destination airport, the Y symbol will be shown on the right side of the display. The **SMALL** knob will scroll through the entries in the order they were sent.

111. 80 s117. 40 PDX 10L 111. 30Y

Remote VOR list

If VOR channels have been sent by a remote device, then this list will be the next available. The channels show the identifier, the “vor” label, and the frequency.

111. 80 s117. 40 UBG vor 117. 40Y

Automatic Nav Channel List

The last ten used active frequencies are available. The channels are stored in chronological order beginning with the most recent used. Duplicates are not saved again, but are moved to the front of the list.

111. 80 s117. 40 autolist 111. 80Y

Nav User Channel List

The Nav channels that you saved are in this list. This list is arranged alphabetically by name. Selection is simply by means of rotating the **SMALL** knob to view the channels.

110. 10 s113. 00 UBG vor 117. 40Y

DST Data Display

When the SL30 has received data from an external device, such as a DME sensor, through the serial port, DST data is added to the Nav recall list. If you aren't connected to an external sensor, you will not see this display. If the display of Distance-Speed-Time (DST) data is not activated, you will be prompted to show the data when you view the DST selection in the channel recall lists.

109. 90 s117. 40 99. 9i 111j 0: 54

Distance from station in nautical miles

Ground speed relative to station in knots

Estimated time to station in hours and minutes

Enable DST Data Display

1. In Nav mode, press **SEL**. Then, turn the **ENT** knob to the DST Data list.

111. 80 s117. 40 show dst data?

2. Press **ENT** to enable the display of DST data. DST information will now replace the Nav information on the Nav mode display.

111. 80 s117. 40 99. 9nm 111kt 0: 54

Disable DST Data Display

1. In Nav mode, press **SEL**. Then, turn the **LARGE** knob to the DST Data item.

111. 80 s117. 40 remove dst data?

2. Press **ENT** to disable the display of DST data. The DST data display may be deactivated by pressing either **T/F** or **OBS** in addition to the "Remove DST Data?" screen.

OBS Mode

OBS Operation

OBS mode enables the VOR CDI which is displayed on the right side. The OBS course setting is shown in the center of the display. The **OBS** button is used to select this mode. If OBS mode is allowed in the unit's installed configuration, the annunciator over the **OBS** button will light. The knobs adjust the OBS setting in this mode rather than the frequencies. The **LARGE** knob adjusts the course by tens (00-35 in higher digits). The **SMALL** knob adjusts single degrees.

OBS Direct-To

You can navigate Direct-To a VOR. In Nav mode with a VOR as the Active frequency, press **OBS** twice. The CDI will now center in the TO condition.

OBS Mode Disabled

If the active frequency is a localizer, OBS mode is not available. Instead, the CDI is always displayed with **LOC** appearing to its left.

OBS mode and the CDI display for VORs are not available if the SL30 is installed with an indicator head that uses a composite converter.

CDI

A CDI display is also available for VORs. The OBS course setting is displayed to the left of the CDI. The CDI graphic is dashed and marked "**flagged**" when no signal is received. If you enabled the "Display Ident over OBS" selection in System mode, the Morse code station

identifier will replace the OBS value when it receives the identifier message.

```
111.80 s117.40 120 fr A}}}
```

```
111.80 s117.40 120 ---fl agged---
```

The CDI display is selected by pressing the **OBS** button. The CDI display is not available if the SL30 is set to use an external indicator head that does not provide a resolver input.

The graphic CDI shows an airplane icon at the center that points up in the To condition or down for From. An area of ambiguity exists when you are on radials that are more than 85° off the OBS course setting. When you are within this range, the airplane icon will be replaced by the “+” symbol.

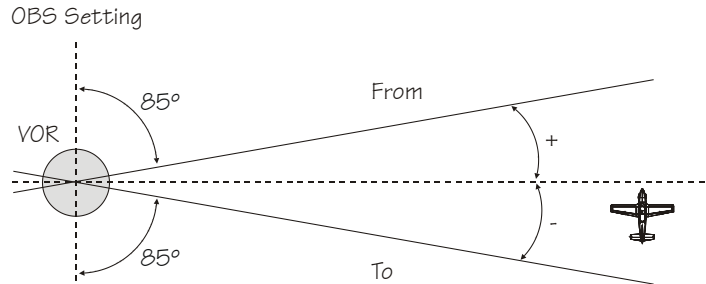

The SL30 graphic CDI is shown as a bar graph of up to five pairs of short and tall bars right or left of the icon. Each short and tall bar pair indicates two degrees deflection. The short bar alone shows partial progress towards a full two degrees. Fly towards the bars to be on course,

except in Back Course mode. When you see only the airplane icon you are on course.

Additional information may be displayed on the clear side of the CDI. This optional information is selected in a system menu and includes a **to** or **from** indicator, a numeric representation of the deflection in tenths of degrees, or nothing at all. Note that the additional information only switches sides after the CDI deflection has exceeded two degrees on the side that is currently used.

Localizer

A localizer (ILS) frequency is distinguished from the VOR OBS display by the label, “**LOC**,” to the left of the CDI rather than the OBS course. If the back course is selected, then “**BC**” will appear as additional information. The “**LOC**” label is replaced by the station’s Morse code identifier after it is decoded. The CDI display will be dashed and marked flagged if no signal is detected on the active channel.

109.90 s117.40 LOC A}}

Back Course

When a localizer channel is active and the SL30 is in Nav mode, the **SEL** button will bring up a prompt to enable or disable the Back Course mode. The **ENT** button will enable the Back Course mode. The **LARGE** knob will still scroll through the recall lists. Back Course mode is not available if the SL30 is set to use an external indicator head with a built-in VOR/LOC converter.

When you set up the Back Course approach in your SL30, no additional setup is required for your HSI or autopilot. The SL30 corrects the Left/Right deviation indications to your HSI and autopilot, if they are coupled to the SL30. In addition, the Glideslope indicator will be

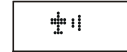

flagged and the needle will be centered. This will make the Back Course approach easier since false or misleading glideslope information is not displayed.

SL30

- 1) Press **NAV** and then set the appropriate Localizer channel into the Active position.
- 2) Enable the Back Course. Press **SEL** and then **ENT**.
111.10 s116.00 Enable backcrs?
- 3) The SL30's internal CDI will show "BC" and the external CDI annunciator will show "BC."

111. 10 s116. 00 | oc bc +}}

- 4) Make sure you are flying a Back Course approach, because the CDI is now reversed so you can still "chase" the needle.

HSI

Do NOT select the reciprocal inbound course. The SL30 will automatically send the correct left/right deviations to your connected HSI.

Autopilot

Do NOT select Back Course in your autopilot if it is connected to the SL30. The SL30 will automatically send the correct information to your connected autopilot.

To/From Radial

The VOR radial display shows the To/From radial computed by the active channel's signal as well as the Morse code channel identifier decoded from the received audio. If no signal is received, the bearing will be dashed. Until the identifier is decoded, "vor" will be displayed.

112. 80 s117. 40 vor from ---

112.80 s117.40 PDX from 115

The **T/F** button selects the To or From radial display. If the VOR radial display is not currently shown, press **T/F** to show the radial display. When the VOR radial is displayed, pressing **T/F** will toggle between the Bearing To and Radial From the VOR. This button is not functional if a localizer frequency is selected on the active channel.

System Mode

Configuration adjustments for the SL30 are made in the System mode. When you press the **SYS** button, the annunciator above the button will light, and the display will change to the System mode menus. The menus available are:

- System info
- Nav options
- Com options
- VOR equipment test

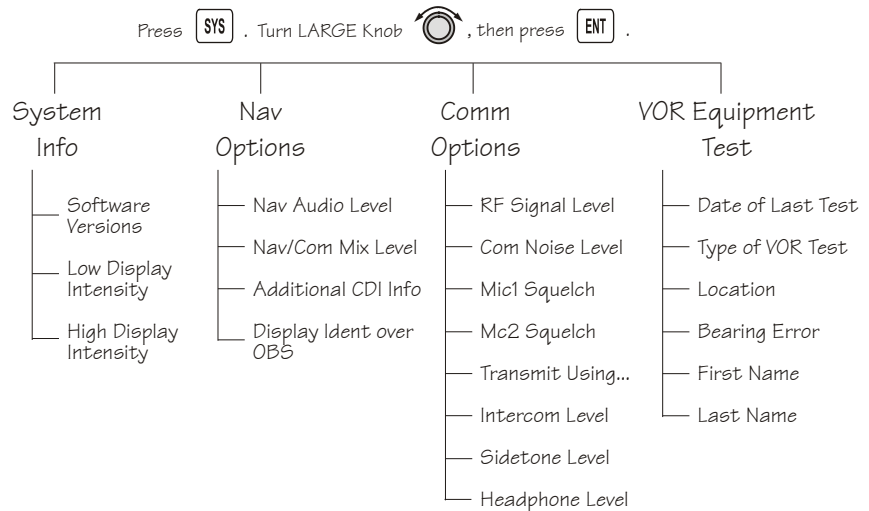

System Info

System Info provides information about the Software versions and the Display Intensity.

1. Press **SYS** and turn the **LARGE** knob if necessary to the System Info page. Press **ENT**.
2. Turn the **LARGE** knob to view the selections.

Software Version

The Software version is available for reference when you contact Technical Support.

1. In the System Info function turn the **LARGE** knob to Nav software version.
2. Turn the **SMALL** knob to view the Nav, Com, and DSP software versions.

Low and High Display Intensity

As it arrives from the factory, the SL30 automatically adjusts its display brightness for the current lighting conditions. A small sensor at the upper left of the display is used for this function. There are two adjustments available for controlling the brightness level of the display. The first controls the lower brightness level in the automatic adjustment range (Low Display Intensity). This is the brightness used when in total darkness. The second adjusts the upper limit of this range (High Display Intensity). This is used when bright light is shining on the display.

The factory settings for these are at the limits of the range, 0 (Low Display Intensity) and 100 (High Display Intensity). The range can be adjusted by using the **SMALL** knob to adjust the two values.

Some users may wish to disable the automatic dimming function. This can be accomplished by setting the high display level to zero. Now the low level adjustment will set the brightness of the display directly with no automatic adjustment made based on ambient light.

Nav Options

Nav Audio Level

This setting is for the SL30's output to its external audio panel. The factory default value is "Variable", which slaves it to the volume knob. The range of values it can be set to are 1 to 100.

Nav/Com Mixing Level

The Nav audio output may be mixed with the com audio output for installations without an audio panel. The default value is "Disabled". The manual adjustment range is 1 to 100. This scale actually represents a level relative to that of the Com audio.

Additional CDI Info

You may optionally select one of a couple of pieces of information to display on the empty side of the VOR CDI. This page allows the user to select this. The options are to leave it blank (NONE), display a To/From indication, or display a numeric value of the deviation (NUMERIC). The numeric deviation is displayed from 0 to 85° with a maximum resolution of 0.1°.

Display Ident over OBS

This is a simple "yes/no" selection. If it is set to No, then the OBS course will always be displayed to the right of the CDI when displayed except when the monitor function is enabled. If this option is set to yes, the Morse code station identifier will replace the OBS course after it is decoded.

Com Options

The Com Options selection allows you to set up options available for Com radio operation.

1. In the System mode rotate the **LARGE** knob to display the Com Options page. Press **ENT**.
2. Rotate the **LARGE** knob to view the Com Options

RF Signal Level

The RF Level function shows the relative signal strength of the active frequency. The value will change as signal conditions change. This information can be used by your dealer to adjust the radio squelch break.

Com Noise Level

The Com Noise Level function shows the relative received noise level of the active frequency. The value will change as signal conditions change.

Mic 1 and 2 Squelch

The input levels required to break squelch by the microphones are set by these values. Lower numbers indicate a higher input level necessary to break squelch. Turn the **LARGE** knob to view Turn the **SMALL** knob to change the value. The range is from 0 to 100.

Transmit Mic

The Transmit Microphone page allows you to control which microphone is permitted to transmit. You may choose Mic 1, 2, or both. To adjust the Transmit Mic control:

1. In the Com Options selection, rotate the **LARGE** knob to display the Transmit Mic page.
2. Rotate the **SMALL** knob to select MIC1, MIC2, or MIC1+MIC2.
3. Select an appropriate frequency, key the transmitter, and talk into the microphones to check for the intended operation.

Intercom Level

This function adjusts the Intercom Audio Level. Turn the **SMALL** knob to change the value. The range is from 1 to 100. Setting the value to “variable” slaves the intercom level to the volume control knob.

Sidetone Level

This function displays and adjusts the sidetone audio level that is heard when the transmitter is keyed. Turn the **SMALL** knob to change the value. The range is from 1 to 100. Setting the value to “variable” slaves the sidetone level to the volume control knob.

Headphone Level

The Headphone Level function allows you to adjust the headphone audio level. Turn the **SMALL** knob to change the value. Setting the value to “variable” slaves the headphone audio level to the volume control knob. The range is from 1 to 100.

VOR Equipment Test

This menu allows you to record information about the most recent equipment check performed on the unit as required for IFR flight. You may include information about: Date of Last Test, Type of VOR Test, Location, Bearing Error, First Name, and Last Name.

1. Press **SYS** to reach System mode and then turn the **LARGE** knob to the VOR Equipment Test function. Press **ENT**.
2. Turn the **LARGE** knob to the desired item.
3. Press **SEL** to enable editing. The **LARGE** knob moves the cursor and the **SMALL** knob adjusts the value at the cursor. Press **ENT** to save the values you selected. Press **SEL** to abort editing.
4. Repeat steps 2 and 3 for all the desired information areas.
5. Press **COM** or **NAV** to leave the System mode. Press **SYS** to go back to the main System mode menu.

Appendix

Troubleshooting

If efforts to resolve the problem fail, contact your dealer or the factory for technical assistance. The Garmin customer service staff will gladly assist you.

Please have the following information ready:

- System configuration (products, antennas, mounting locations, etc.)
- Model No., part number, and serial number
- Software versions
- Description of the problem
- Efforts made to isolate/solve the problem

Garmin International, Inc.
Customer Service Department
1200 East 151st Street
Olathe, KS 66062-3426 USA
(913) 397-8200
FAX (913) 397-8282

<http://www.garmin.com>

Appendix

Problem	Possible Cause	Action
SL30 does not power on	No power to the SL30	Check power connections, breakers, and main avionics switch
	Faulty electrical wiring or connection	Contact your dealer to perform electrical system test
No Nav audio	Output disabled or set to a low level	Check System page, Nav options, Nav Audio Level
Nav audio in Com	Mixed with Com feature	Check System page, Nav Options, Mix Nav Audio with Com
SL30 does not transmit	Weather channel is selected	Select a different frequency, transmit on Weather channel not allowed
	No power to Com	Check power connections
	Mic key connection	Check Mic key input connection
Sidetone level is too low or too high	Wrong type of headsets, or level needs adjustment	Check System page, Nav Options, Sidetone level

Problem	Possible Cause	Action
Intercom doesn't function	Input not connected	Check connections
	No voice activation, or must talk too loud	Check System page, Com Options, Intercom level
Can't change active frequency	Com Radio not communicating	Contact dealer
OBS readout displays "---"	Resolver failure	Contact dealer
	Calibration error	Recalibrate resolver
Display shows "Incorrect Calibration Checksum" at start-up	Corrupted system calibration parameters	Contact factory

Installation Configurations

Certain functions are either available or not depending on the configuration of your particular installation. The following table illustrates the features available for the described installations. A feature that is available is indicated by the black dot.

	VOR Monitor	VOR CDI Display	Localizer Back Course	OBS Mode/OBS Direct-To	Glideslope Info See Note 1
Stand-Alone	●	●	●	●	
External CDI/HSI Resolver	●	●	●		●
External CDI/HSI Resolver with VOR/LOC Converter					●
External Serial CDI/HSI	●	●	●		●

Note 1 - External indicator must support vertical deviation indication to the pilot.

Specifications

General Features

32 character high-intensity alphanumeric LED display

Sunlight readable full alphanumeric display

Automatic display intensity

Back-lit buttons

200 channel memory (stored alphabetically)

Remote frequency flip-flop input pin

Navigation Radio Features

200 channel Nav with solid state DSP technology

VOR/Localizer and Glideslope receivers

Built-in VOR/Localizer converter

Frequency range:

VOR 108.00 – 117.95 MHz

Localizer 108.00 – 111.95 MHz

Glideslope 328.60 – 335.40 MHz

Digitally decoded OBS setting

Manual selection of back course approach

Automatic display of station ID by decoding Morse code

Interfaces to most CDI (w/resolver), HSI, and autopilot systems

VOR receiver displays To or From radial of the active channel

VOR monitor displays From radial of the standby channel

Back course annunciator output

LOC enable annunciator output

Internal RF diplexor

Active and standby flip/flop frequencies

DME or other DST (Distance, Speed, Time) tuning an data display

Com Radio Features

760 communications channels

Frequency range 118 to 136.975 MHz

Active and standby flip/flop frequencies

Volume control

Tunes to National Weather Service broadcasts

Transmit status indicator

Frequency monitor function (listens to standby while monitoring active)

Emergency channel menu

Squelch test function

Stuck Mic time-out

12 watt audio amplifier

Includes two-place VOX intercom

Physical Specifications

1.3”(H) x 6.25” (W) x 10.5” (D)

Weight 2.25 lbs. (unit only)

Depth 11.452 inches (29.09cm) behind panel, including mounting frame and connectors

NAV Radio Performance Specifications

Input voltage range 10 to 40 VDC

Operating temperature range -20°C to $+55^{\circ}\text{C}$

Certified TSO C34e/JTSO C34e (Glideslope receive)

Certified TSO C36e/JTSO C36e (ILS Localizer receive)

Certified TSO C40c/JTSO 2C40c (VOR receive)

Certified TSO C66c/JTSO 2C66b (DME display)

Com Radio Performance Specifications

Input voltage range 10 to 40 VDC

Operating temperature range -20°C to $+55^{\circ}\text{C}$

Transmit power 8 watts (Carrier Power)

Certified TSO C37d/JTSO 2C37e (Com transmitting)

Certified TSO C38d/JTSO 2C38e (Com receiving)

Certified TSO C128/JTSO 2C128 (stuck mic)

System Interfaces

Navigation Receiver

The SL30 can be installed in several configurations based upon individual requirements. This includes with or without an external course deviation indicator. The CDI may be discrete, serial, or composite.

Com Transceiver

For standalone installations, the Com requires connections to:

- a standard Com antenna
- a microphone (or microphones)
- a speaker or headphone
- power input

These items may be installed dedicated to the SL30 Com, or by connection to an audio panel. The system can be configured to mix the NAV audio with the Com audio if no external audio panel is used.

Serial Interface

DST or DME – Distance, Speed, Time or Distance Measure Equipment

SL/GX – GPS products

MX – Multi-Function Display

Localizer and Paired Glideslope Frequencies

Localizer MHz	Glideslope MHz	Localizer MHz	Glideslope MHz
108.10	334.70	110.10	334.40
108.15	334.55	110.15	334.25
108.30	334.10	110.30	335.00
108.35	333.95	110.35	334.85
108.50	329.90	110.50	329.60
108.55	329.75	110.55	329.45
108.70	330.50	110.70	330.20
108.75	330.35	110.75	330.05
108.90	329.30	110.90	330.80
108.95	329.15	110.95	330.65
109.10	331.40	111.10	331.70
109.15	331.25	111.15	331.55
109.30	332.00	111.30	332.30
109.35	331.85	111.35	332.15
109.50	332.60	111.50	332.90
109.55	332.45	111.55	332.75
109.70	333.20	111.70	333.50

Appendix

Localizer MHz	Glideslope MHz	Localizer MHz	Glideslope MHz
109.75	333.05	111.75	333.35
109.90	333.80	111.90	331.10
109.95	333.65	111.95	330.95

Each displayed localizer frequency is paired with a glideslope frequency that is not displayed.

VOR Station Frequencies

VOR stations occur every 50 kHz from 112.00 through 117.95 MHz and on the following frequencies in the 108 to 112 MHz band.

108.20	109.20	110.20	111.20
108.25	109.25	110.25	111.25
108.40	109.40	110.40	111.40
108.45	109.45	110.45	111.45
108.60	109.60	110.60	111.60
108.65	109.65	110.65	111.65
108.80	109.80	110.80	111.80
108.85	109.85	110.85	111.85
109.00	110.00	111.00	112.00
109.05	110.05	111.05	

Compliance, License, and Warranty Information

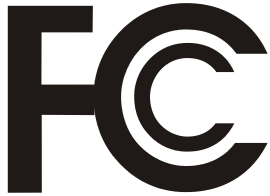

FCC Compliance

The SL30 complies with Part 15 of the FCC interference limits for Class B digital devices FOR HOME OR OFFICE USE. These limits are designed to provide more reasonable protection against harmful interference in a residential installation, and are more stringent than “outdoor” requirements.

Operation of this device is subject to the following conditions: (1) This device may not cause harmful interference, and (2) this device must accept any interference received, including interference that may cause undesired operation.

This equipment generates, uses and can radiate radio frequency energy and, if not installed and used in accordance with the instructions, may cause harmful interference to radio communications. However, there is no guarantee that interference will not occur in a particular installation. If this equipment does cause harmful interference to radio or television reception, which can be determined by turning the equipment off and on, the user is encouraged to try to correct the interference by one of the following measures:

- Reorient or relocate the receiving antenna.
- Increase the separation between the equipment and the receiver.
- Connect the equipment into an outlet on a circuit different from that to which the receiver is connected.
- Consult the dealer or an experienced radio/TV technician for help.

The SL30 does not contain any user-serviceable parts. Repairs should only be made by an authorized Garmin service center. Unauthorized repairs or modifications could result in permanent damage to the equipment, and void your warranty and your authority to operate this device under Part 15 regulations.

Software License Agreement

BY USING THE SL30, YOU AGREE TO BE BOUND BY THE TERMS AND CONDITIONS OF THE FOLLOWING SOFTWARE LICENSE AGREEMENT. PLEASE READ THIS AGREEMENT CAREFULLY.

Garmin grants you a limited license to use the software embedded in this device (the “Software”) in binary executable form in the normal operation of the product. Title, ownership rights, and intellectual property rights in and to the Software remain in Garmin.

You acknowledge that the Software is the property of Garmin and is protected under the United States of America copyright laws and international copyright treaties. You further acknowledge that the structure, organization, and code of the Software are valuable trade secrets of Garmin and that the Software in source code form remains a valuable trade secret of Garmin. You agree not to decompile, disassemble, modify, reverse assemble, reverse engineer or reduce to human readable form the Software or any part thereof or create any derivative works based on the Software. You agree not to export or re-export the Software to any country in violation of the export control laws of the United States of America.

Product Registration and Support

Help us better support you by completing your online registration today! Have the serial number of your SL30 handy and connect to the Garmin Web site (www.garmin.com). Look for the Product Registration link on the home page. Also, be sure to record your serial number in the space provided to the left.

If you have any questions, Garmin’s Product Support department may be reached Monday through Friday, 8:00 AM to 5:00 PM Central Standard Time, by phone at **1-800-800-1020**, or by e-mail at **sales@garmin.com**.

Compliance, License, and Warranty Information

Serial Number

Use this area to record the serial number in case it is lost, stolen, or needs service. Be sure to keep your original sales receipt in a safe place or attach a photocopy inside the manual. The 8-digit number is located on the back of the unit.

Serial Number:

<input type="text"/>	<input type="text"/>	<input type="text"/>	<input type="text"/>	<input type="text"/>	<input type="text"/>	<input type="text"/>	<input type="text"/>
----------------------	----------------------	----------------------	----------------------	----------------------	----------------------	----------------------	----------------------

NOTE: If you have previously registered a Garmin product purchase, we invite you to re-register using our NEW on-line system. Many services provided by our new product registration system are now being automated and re-registering your purchase ensures you the best possible support from Garmin.

Limited Warranty

This Garmin product is warranted to be free from defects in materials or workmanship for one year from the date of purchase. Within this period, Garmin will at its sole option, repair or replace any components that fail in normal use. Such repairs or replacement will be made at no charge to the customer for parts or labor, provided that the customer shall be responsible for any transportation cost. This warranty does not cover failures due to abuse, misuse, accident or unauthorized alteration or repairs.

THE WARRANTIES AND REMEDIES CONTAINED HEREIN ARE EXCLUSIVE AND IN LIEU OF ALL OTHER WARRANTIES EXPRESS OR IMPLIED OR STATUTORY, INCLUDING ANY LIABILITY ARISING UNDER ANY WARRANTY OF MERCHANTABILITY OR FITNESS FOR A PARTICULAR PURPOSE, STATUTORY OR OTHERWISE. THIS WARRANTY GIVES YOU SPECIFIC LEGAL RIGHTS, WHICH MAY VARY FROM STATE TO STATE.

IN NO EVENT SHALL GARMIN BE LIABLE FOR ANY INCIDENTAL, SPECIAL, INDIRECT OR CONSEQUENTIAL DAMAGES, WHETHER RESULTING FROM THE USE, MISUSE, OR INABILITY TO USE THIS PRODUCT OR FROM DEFECTS IN THE PRODUCT. Some states do not allow the exclusion of incidental or consequential damages, so the above limitations may not apply to you.

Garmin retains the exclusive right to repair or replace the unit or software or offer a full refund of the purchase price at its sole discretion. SUCH REMEDY SHALL BE YOUR SOLE AND EXCLUSIVE REMEDY FOR ANY BREACH OF WARRANTY.

To obtain warranty service, call your local Garmin authorized dealer, or call Garmin Customer Service at one of the numbers listed to the left for shipping instructions and an RMA tracking number. The unit should be securely packed with the tracking number clearly written on the outside of the package. The unit should be sent, freight charges prepaid, to any Garmin warranty service station. A copy of the original sales receipt is required as the proof of purchase for warranty repairs.

Products sold through online auctions are not eligible for rebates or other special offers from Garmin. Online auction confirmations are not accepted for warranty verification. To obtain warranty service, an original or copy of the sales receipt from the original retailer is required. Garmin will not replace missing components from any package purchased through an online auction.

Index

A

Arrow button 3
 Audio;Mixing level 30
 Audio channel 18
 Audio level 30
 Autolist;Com channel 12
 Autolist;Nav 21
 Autopilot 26

B

Back course 16, 25

C

CDI 23, 30
 Com;Autolist 12
 Com;Button 3
 Com;Recall channel 11
 Com;Remote channel 12
 Com;Remove channel 10
 Com;Save channel 9

Com;Select frequency 6
 Com;User channels 12
 Com noise level 31
 Com options 31
 Configuration 36

D

Direct-To 23
 Display 2
 Display intensity 29
 Distance data 22
 DME display 22
 DST Data Display 22

E

Emergency channel 13
 Enter (ENT);Button 4

F

FCC Compliance 44
 Flip/Flop;Button 3
 Frequencies;Localizer 41
 Frequencies;Type 9
 Frequencies;VOR 43

Front panel 1

G

Getting started 1
 Glideslope;Frequencies 41

H

Headphone 32
 HSI 26

I

Ident (ID);Button 4
 ID mode 18
 Installation configuration 36
 Intercom 14, 32

K

Knobs 2

L

Limited Warranty 46
 Localizer 25
 Localizer;Frequencies 41

M

Mic 31
 Monitor;Standby Com channel 9
 Monitor;Standby Nav channel 15
 Morse code i, 1, 18, 23, 25, 26,
 30

N

Nav/Com audio mixing 30
 Nav;Audio level 30
 Nav;Autolist channels 21
 Nav;Button 3
 Nav;Mode 15
 Nav;Monitor standby 15
 Nav;Options 30
 Nav;Save channel 19
 Nav;Select frequency 6

O

OBS 7, 23
 OBS;Button 3
 OBS;Direct-To 23
 OBS;Disabled 23
 OBS;Display ident 30

Index

P

Power 2
Product Support 45

R

Recall;Com channels 11
Recalling frequencies 7
Registration 45
Remote;Com channels 12
Remote;VOR list 21
Remove Com channel 10
RF signal level 31

S

Save;Com channels 9
Save;Nav channel 19
Select (SEL);Button 4
Serial Number 45
Sidetone 32
Software version 29
Specifications 37
Speed data 22
Squelch 2, 31
Standby;Com 9

Standby;Nav 15
Stuck mic 14
Support 45
System 28
System (SYS);Button 3

T

Time data 22
To/From;Button 3
To/From;Radial 26
Troubleshooting 33

U

User channels 12, 21

V

Volume 2
VOR;Equipment test 32
VOR;Frequencies 43

W

Warranty 46

Weather channels 13



© 2004 Garmin Ltd. or its subsidiaries

Garmin International, Inc.
1200 East 151st Street, Olathe, Kansas 66062, U.S.A.

Garmin (Europe) Ltd.
Unit 5, The Quadrangle, Abbey Park Industrial Estate, Romsey, SO51 9DL, U.K.

Garmin Corporation
No. 68, Jangshu 2nd Road, Shijr, Taipei County, Taiwan

www.garmin.com

Part Number 560-0403-01 Rev. C (Garmin P/N 190-00486-00)